

Ametz SISTEMAS TRANSPORTES NEUMÁTICO PNEUMATIC TRANSPORTS SYSTEMS

Ametz TRANSPORTES NEUMÁTICOS DE ALTO RENDIMIENTO, EN BASE A LAS CARACTERÍSTICAS DE LOS MATERIALES A TRANSPORTAR, DIMENSIONES Y TRAZADO DE LA TUBERÍA, Y LAS CONDICIONES DE OPERACIÓN DEL SISTEMA PARA UN MATERIAL Y SISTEMA DE TRANSPORTE NEUMÁTICO EN PARTICULAR

Ametz SISTEMAS DE TRANSPORTE NEUMÁTICO POR IMPULSION Y POR ASPIRACION

Ametz VENTAJAS DEL TRANSPORTE NEUMÁTICO ES LA NO-CONTAMINACION

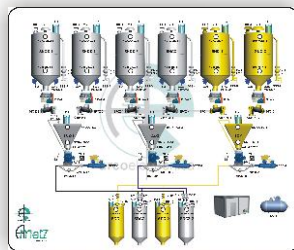
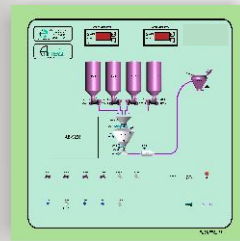

Ametz
ARCO MET 7, S.L.



www.arcomet7.com
arcomet7@arcomet7.com



SISTEMAS TRANSPORTES NEUMATICO PNEUMATIC TRANSPORTS SYSTEMS

EQUIPOS SISTEMAS DE TRANSPORTE NEUMATICO VERSION BIG.BAG

EQUIPOS SISTEMAS DE TRANSPORTE NEUMATICO VERSION ROMPESACOS

CARACTERISTICAS:

PRODUCCION 10Tn/h

MATERIAL: CEMENTO

POTENCIA: 25.37 Kw

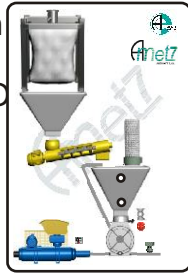

DIMENSIONES GENERALES

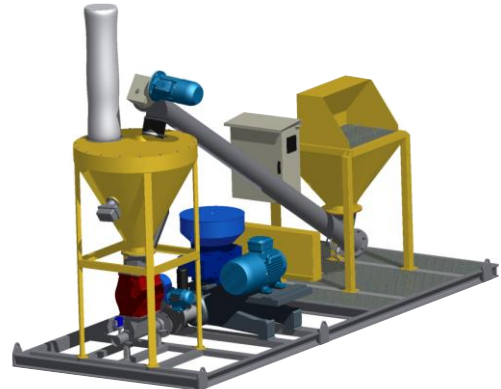
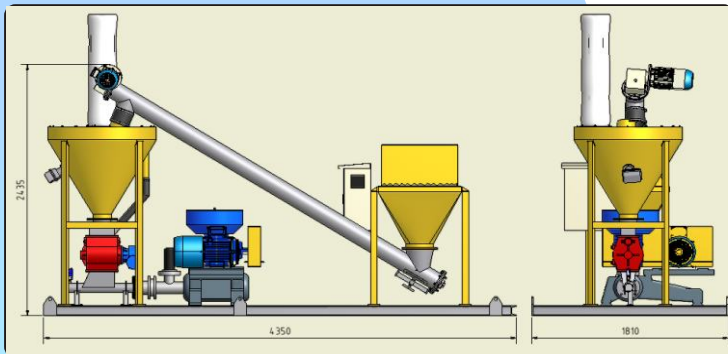
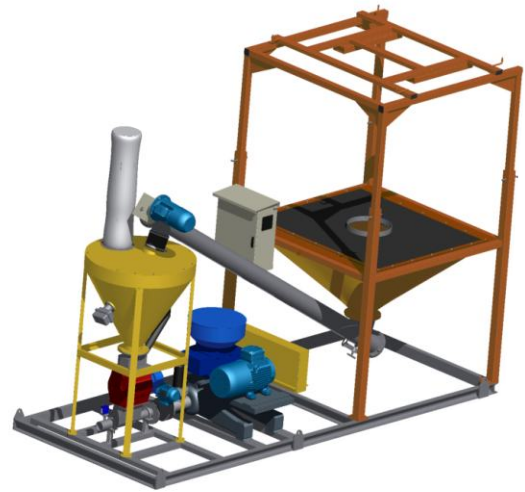
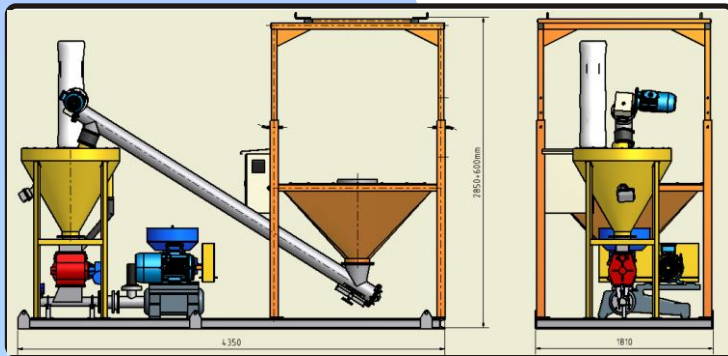

www.arcomet7.com
arcomet7@arcomet7.com

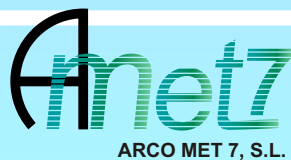

Polígono "La Cuesta I", C/Castilla-León, 5-7
50100 La Almunia de Doña Godina
Zaragoza - ESPAÑA
Tfno. 976 819010 - 976 819089
FAX. 976 812654
www.arcomet7.com
arcomet7@arcomet7.com

 DELEGACIÓN
ZONA CATALUÑA
Tel. 619 70 36 20

 DELEGACIÓN
ZONA CENTRO
Tel. 680 980 628

 ARLACO COMERCIO E
INDUSTRIA LDA.
Tel. 00.35.1227128279
(PORTUGAL)

 ARCO FRANCE 9 S.A.
Tel. 976 819 010
(FRANCIA)